

# PA51 • PA51A

## FEATURES

- WIDE SUPPLY RANGE —  $\pm 10$  to  $\pm 40V$
- HIGH OUTPUT CURRENT —  $\pm 10A$  Peak
- CLASS "C" OUTPUT — Low Cost
- LOW QUIESCENT CURRENT — 2.6mA

## APPLICATIONS

- DC SERVO AMPLIFIER
- MOTOR/SYNCHRO DRIVER
- VALVE AND ACTUATOR CONTROL
- DC OR AC POWER REGULATOR

## DESCRIPTION

The PA51 and PA51A are high voltage, high output current operational amplifiers designed to drive resistive, inductive and capacitive loads. Their complementary common emitter output stage is the simple class C type optimized for low frequency applications where crossover distortion is not critical. These amplifiers are not recommended for audio, transducer or deflection coil drive circuits. The safe operating area (SOA) is fully specified and can be observed for all operating conditions by selection of user programmable current limiting resistors. Both amplifiers are internally compensated for all gain settings. For continuous operation under load, mounting on a heatsink of proper rating is recommended. Do not use isolation washers!

This hybrid integrated circuit utilizes thick film conductors, ceramic capacitors and semiconductor chips to maximize reliability, minimize size and give top performance. Ultrasonically bonded aluminum wires provide reliable interconnections at all operating temperatures. The 8-pin TO-3 package is electrically isolated and hermetically sealed. The use of compressible thermal washers and/or improper mounting torque will void the product warranty. Please see "General Operating Considerations".

## EQUIVALENT SCHEMATIC

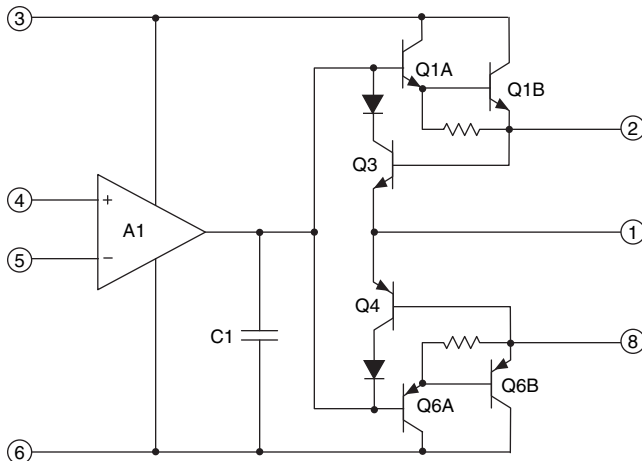

8-PIN TO-3  
PACKAGE STYLE CE

## TYPICAL APPLICATION

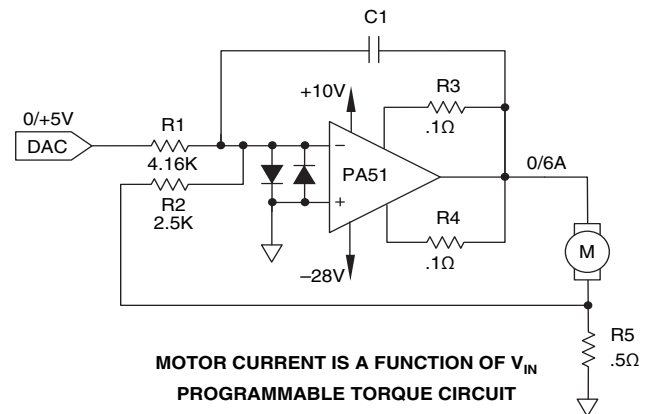

The linear relationship of torque output to current input of the modern torque motor makes this simple control circuit ideal for many material processing and testing applications. The sense resistor develops a feedback voltage proportional to motor current and the small signal properties of the Power Op Amp insure accuracy. With this closed loop operation, temperature induced impedance variations of the motor winding are automatically compensated.

## EXTERNAL CONNECTIONS

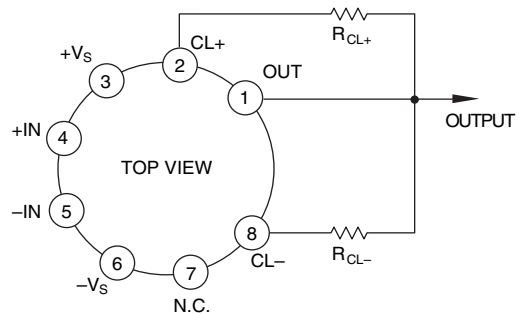

ABSOLUTE MAXIMUM RATINGS

SUPPLY VOLTAGE, $+V_S$ to $-V_S$	80V
OUTPUT CURRENT, within SOA	10A
POWER DISSIPATION, internal	97W
INPUT VOLTAGE, differential	$\pm V_S - 3V$
INPUT VOLTAGE, common mode	$\pm V_S$
TEMPERATURE, junction <sup>1</sup>	200°C
TEMPERATURE, pin solder -10s	300°C
TEMPERATURE RANGE, storage	-65 to +150°C
OPERATING TEMPERATURE RANGE, case	-55 to +125°C

SPECIFICATIONS

PARAMETER	TEST CONDITIONS <sup>2,5</sup>	PA51			PA51A			UNITS
		MIN	TYP	MAX	MIN	TYP	MAX	
<b>INPUT</b>								
OFFSET VOLTAGE, initial	$T_C = 25^\circ\text{C}$		$\pm 5$	$\pm 10$		$\pm 2$	$\pm 5$	mV
OFFSET VOLTAGE, vs. temperature	Full temperature range		$\pm 10$	$\pm 65$		*	$\pm 40$	$\mu\text{V}/^\circ\text{C}$
OFFSET VOLTAGE, vs. supply	$T_C = 25^\circ\text{C}$		$\pm 35$			*		$\mu\text{V}/\text{V}$
OFFSET VOLTAGE, vs. power	$T_C = 25^\circ\text{C}$		$\pm 20$			*		$\mu\text{V}/\text{W}$
BIAS CURRENT, initial	$T_C = 25^\circ\text{C}$		$\pm 15$	$\pm 40$		*	$\pm 20$	nA
BIAS CURRENT, vs. temperature	Full temperature range		$\pm 0.05$			*		$\text{nA}/^\circ\text{C}$
BIAS CURRENT, vs. supply	$T_C = 25^\circ\text{C}$		$\pm 0.02$			*		$\text{nA}/\text{V}$
OFFSET CURRENT, initial	$T_C = 25^\circ\text{C}$		$\pm 12$	$\pm 30$		$\pm 5$	$\pm 10$	nA
OFFSET CURRENT, vs. temperature	Full temperature range		$\pm 0.05$			*		$\text{nA}/^\circ\text{C}$
INPUT IMPEDANCE, common mode	$T_C = 25^\circ\text{C}$		250			*		M $\Omega$
INPUT IMPEDANCE, differential	$T_C = 25^\circ\text{C}$		10			*		M $\Omega$
INPUT CAPACITANCE	$T_C = 25^\circ\text{C}$		3			*		pF
COMMON MODE VOLTAGE RANGE <sup>3</sup>	Full temperature range	$\pm V_S - 6$	$\pm V_S - 3$		*	*		V
COMMON MODE REJECTION, DC <sup>3</sup>	$T_C = 25^\circ\text{C}, V_{CM} = \pm V_S - 6V$	70	110		80	*		dB
<b>GAIN</b>								
OPEN LOOP GAIN at 10Hz	Full temp. range, full load	94	115		*	*		dB
GAIN BANDWIDTH PRODUCT @ 1MHz	$T_C = 25^\circ\text{C}$ , full load		1			*		MHz
POWER BANDWIDTH	$T_C = 25^\circ\text{C}, I_O = 8A, V_O = 40V_{PP}$	10	16		*	*		kHz
PHASE MARGIN	Full temperature range		45			*		°
<b>OUTPUT</b>								
VOLTAGE SWING <sup>3</sup>	$T_C = 25^\circ\text{C}, I_O = 10A$	$\pm V_S - 8$	$\pm V_S - 5$		*	*		V
VOLTAGE SWING <sup>3</sup>	Full temp. range, $I_O = 4A$	$\pm V_S - 6$	$\pm V_S - 4$		*	*		V
VOLTAGE SWING <sup>3</sup>	Full temp. range, $I_O = 68\text{mA}$	$\pm V_S - 6$			*	*		V
CURRENT	$T_C = 25^\circ\text{C}$	$\pm 10$			*	*		A
SETTLING TIME to .1%	$T_C = 25^\circ\text{C}, 2V$ step		2			*		$\mu\text{s}$
SLEW RATE	$T_C = 25^\circ\text{C}, R_L = 6\Omega$	1.0	2.6		*	*		$\text{V}/\mu\text{s}$
CAPACITIVE LOAD, unity gain	Full temperature range			1.5		*	*	nF
CAPACITIVE LOAD, gain > 4	Full temperature range			SOA		*	*	nF
<b>POWER SUPPLY</b>								
VOLTAGE	Full temperature range	$\pm 10$	$\pm 28$	$\pm 36$	*	$\pm 34$	$\pm 40$	V
CURRENT, quiescent	$T_C = 25^\circ\text{C}$		2.6	10		*	*	mA
<b>THERMAL</b>								
RESISTANCE, AC, junction to case <sup>4</sup>	$F > 60\text{Hz}$		1.0	1.2		*	*	$^\circ\text{C}/\text{W}$
RESISTANCE, DC, junction to case	$F < 60\text{Hz}$		1.5	1.8		*	*	$^\circ\text{C}/\text{W}$
RESISTANCE, junction to air			30			*		$^\circ\text{C}/\text{W}$
TEMPERATURE RANGE, case	Meets full range specifications	-25		+85	-55		+125	$^\circ\text{C}$

NOTES: \* The specification of PA51A is identical to the specification for PA51 in applicable column to the left.

1.  $Lo$  achieve high MTF.
2. The power supply voltage specified under the TYP rating applies unless otherwise noted as a test condition.
3.  $+V_S$  and  $-V_S$  denote the positive and negative supply rail respectively. Total  $V_S$  is measured from  $+V_S$  to  $-V_S$ .
4. Rating applies if the output current alternates between both output transistors at a rate faster than 60Hz.
5. Full temperature range specifications are guaranteed but not 100% tested.

**CAUTION**

The internal substrate contains beryllia (BeO). Do not break the seal. If accidentally broken, do not crush, machine, or subject to temperatures in excess of 850°C to avoid generating toxic fumes.

# PA51 • PA51A

## TYPICAL PERFORMANCE GRAPHS

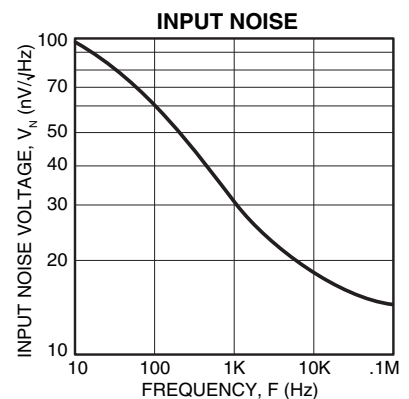
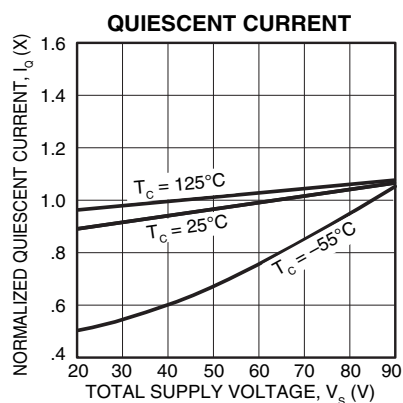
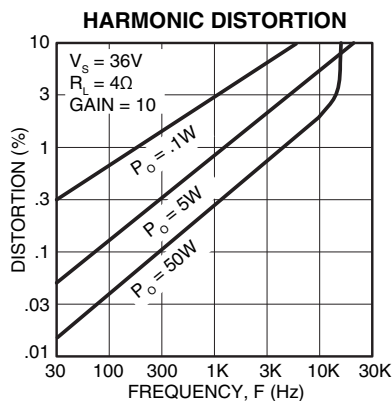
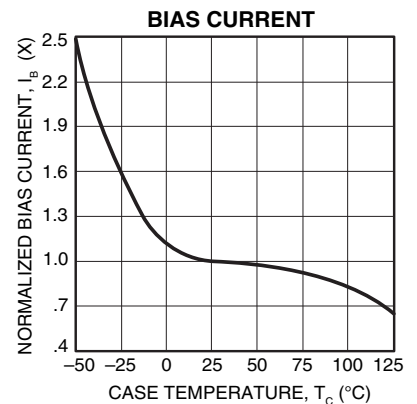
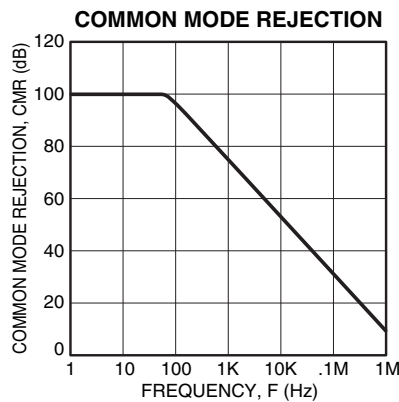
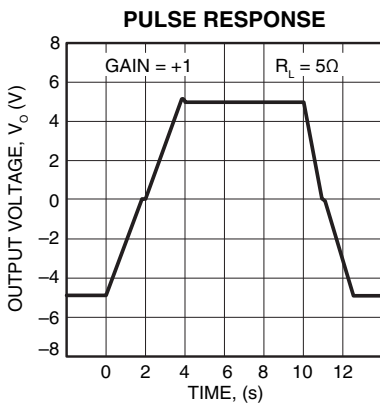
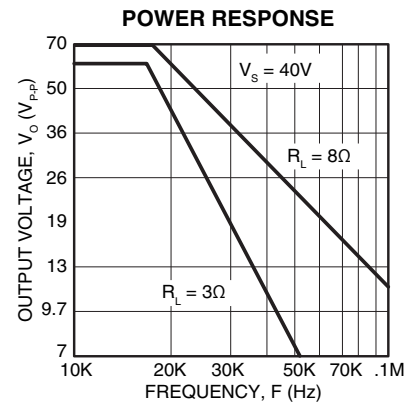
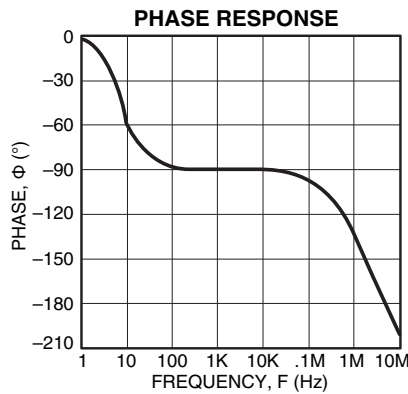
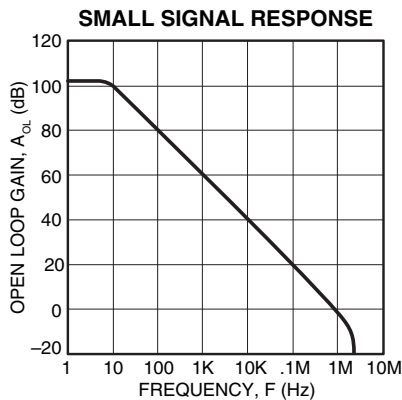
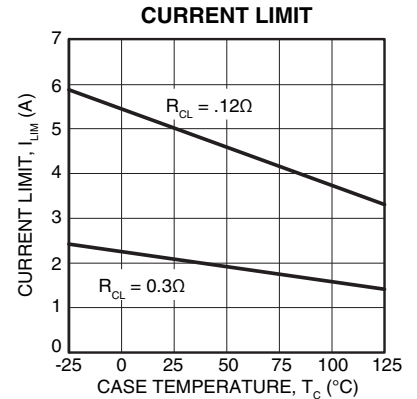
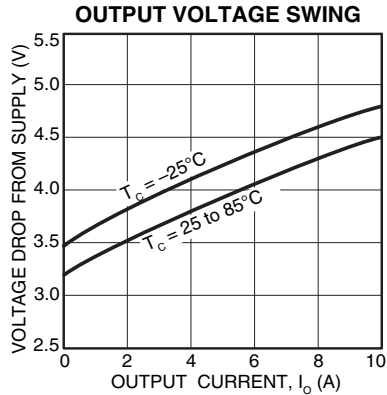
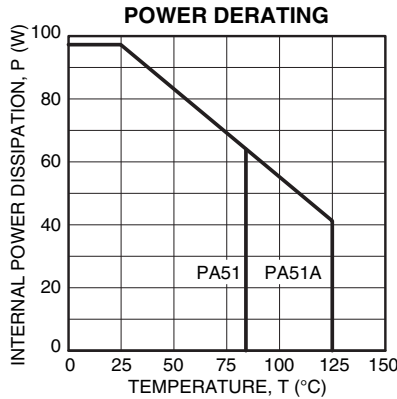

**GENERAL**

Please read Application Note 1 "General Operating Considerations" which covers stability, supplies, heat sinking, mounting, current limit, SOA interpretation, and specification interpretation. Visit [www.apexmicrotech.com](http://www.apexmicrotech.com) for design tools that help automate tasks such as calculations for stability, internal power dissipation, current limit and heat sink selection. The "Application Notes" and "Technical Seminar" sections contain a wealth of information on specific types of applications. Package outlines, heat sinks, mounting hardware and other accessories are located in the "Packages and Accessories" section. Evaluation Kits are available for most Apex product models, consult the "Evaluation Kit" section for details. For the most current version of all Apex product data sheets, visit [www.apexmicrotech.com](http://www.apexmicrotech.com).

**SAFE OPERATING AREA (SOA)**

The output stage of most power amplifiers has three distinct limitations:

1. The current handling capability of the transistor geometry and the wire bonds.
2. The second breakdown effect which occurs whenever the simultaneous collector current and collector-emitter voltage exceeds specified limits.
3. The junction temperature of the output transistors.

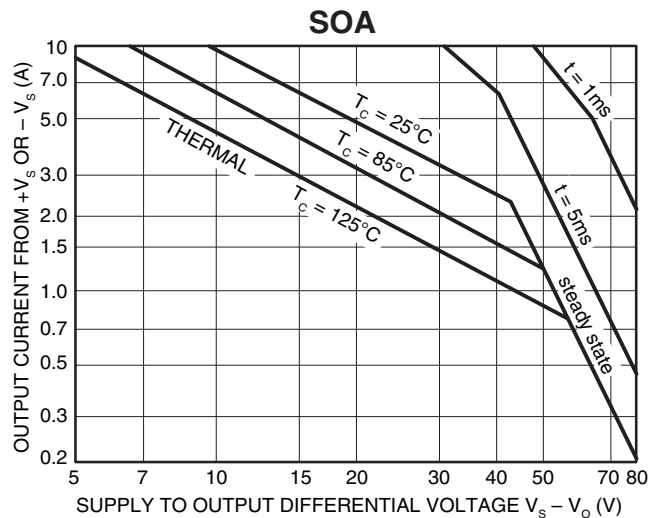

The SOA curves combine the effect of all limits for this Power Op Amp. For a given application, the direction and magnitude of the output current should be calculated or measured and checked against the SOA curves. This is simple for resistive loads but more complex for reactive and EMF generating loads. The following guidelines may save extensive analytical efforts.

1. Under transient conditions, capacitive and dynamic\* inductive loads up to the following maximums are safe:

$\pm V_s$	CAPACITIVE LOAD		INDUCTIVE LOAD	
	$I_{LIM} = 5A$	$I_{LIM} = 10A$	$I_{LIM} = 5A$	$I_{LIM} = 10A$
40V	400 $\mu$ F	200 $\mu$ F	11mH	4.3mH
35V	800 $\mu$ F	400 $\mu$ F	20mH	5.0mH
30V	1,600 $\mu$ F	800 $\mu$ F	35mH	6.2mH
25V	5.0mF	2.5mF	50mH	15mH
20V	10mF	5.0mF	400mH	20mH
15V	20mF	10mF	**	100mH

\* If the inductive load is driven near steady state conditions, allowing the output voltage to drop more than 8V below the supply rail with  $I_{LIM} = 10A$  or 15V below the supply rail with  $I_{LIM} = 5A$  while the amplifier is current limiting, the inductor should be capacitively coupled or the current limit must be lowered to meet SOA criteria.

\*\* Second breakdown effect imposes no limitation but thermal limitations must still be observed.

2. The amplifier can handle any EMF generating or reactive load and short circuits to the supply rail or shorts to common if the current limits are set as follows at  $T_c = 85^\circ C$ .

$\pm V_s$	SHORT TO $\pm V_s$ C, L, OR EMF LOAD	SHORT TO COMMON
	45V	0.1A
40V	0.2A	1.5A
35V	0.3A	1.6A
30V	0.5A	2.0A
25V	1.2A	2.4A
20V	1.5A	3.0A
15V	2.0A	4.0A

These simplified limits may be exceeded with further analysis using the operating conditions for a specific application.

3. The output stage is protected against transient flyback. However, for protection against sustained, high energy flyback, external fast-recovery diodes should be used.

**CURRENT LIMIT**

Proper operation requires the use of two current limit resistors, connected as shown in the external connection diagram. The minimum value for  $R_{CL}$  is .06 ohm, however for optimum reliability it should be set as high as possible. Refer to the "General Operating Considerations" section of the handbook for current limit adjust details.